

**Panasonic®**

**Personal Computer**

# OPERATING INSTRUCTIONS

**CF-27 Series**

**TOUGHBOOK**

95

**[Additional Manual]  
Reference Manual**

This manual can be accessed on your computer. Please refer to page 15 on how to access the Reference Manual.

**Contents**

- Key Combinations
- LED Indicators
- Panasonic Hand Writing (Touch Pad)
- Suspend/Hibernation Functions
- Security Measures
- Computing On the Road
- Battery Power
- Using a Multimedia Pocket Device
- Using PC Cards
- Adding Memory
- Port Replicator
- Using a Printer
- Using an External Display
- Using USB Devices
- Infrared Data Communications
- Hard Disk Drive
- Setup Utility
- Technical Information
- List of Error Codes
- DMI Viewer
- Dealing With Problems

## Contents

### Getting Started

Read Me First .....	5
First-time Operation .....	6

### Operation

Starting Up/Shutting Down .....	10
Handling and Maintenance .....	16

### Troubleshooting

List of Error Codes .....	17
Dealing With Problems .....	18
Reinstalling Software .....	20

### Appendix

LIMITED USE LICENSE AGREEMENT .....	23
Names and Functions of Parts .....	25
Specifications .....	27

Getting Started

Operation

Troubleshooting

Appendix



<b>Customer's Record</b>	
Model No.* _____	Dealer's Name _____
Serial No. _____	_____
or	
Code No. _____	Dealer's Address _____
Date of Purchase _____	_____

\*For the Model No., insert the 11 digit number (for example, CF-27RJ48AAM) located on the bottom of the computer.

## Introduction

Thank you for purchasing the Panasonic computer. Please read the operating instructions thoroughly for proper operation of your new computer.

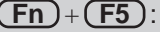
## Illustrations in this manual

- NOTE:** **NOTE** provides a useful fact or helpful information.
- CAUTION:** **CAUTION** indicates a condition that may result in minor or moderate injury.
- WARNING:** **WARNING** indicates a hazard that may result in moderate or serious injury.
- [Start] - [Shut Down]: This illustration means to click [Start], then to click [Shut Down].  
(For some applications, you may need to double-click.)
- : This illustration means to press the [Enter] key.
- : This illustration means to press and hold the [Fn] key, then press the [F5] key.
- : Where to go for referred information.
-  **Reference Manual**: This illustration means to refer to the Reference Manual, which is available on your computer. Please refer to page 15 on how to access this manual.

## Copyright

This manual is copyrighted by Matsushita Electric Industrial Co., Ltd. with all rights reserved. No part of this manual may be reproduced in any form without the prior written permission of Matsushita Electric Industrial Co., Ltd. No patent liability is assumed with respect to the use of the information contained herein.

©Matsushita Electric Industrial Co., Ltd. 1998. All Rights Reserved.

## Disclaimer

Computer specifications and manuals are subject to change without notice. Matsushita Electric Industrial Co., Ltd. assumes no liability for damage incurred directly or indirectly from errors, omissions or discrepancies between the computer and the manuals.

## Trademarks

PS/2™ is a trademark of International Business Machines Corporation.

Microsoft, MS-DOS, Windows and IntelliMouse are registered trademarks of Microsoft Corporation of the United States and/or other countries.

Pentium is a registered trademark of Intel Corporation.

PhoenixCard Manager is a trademark of Phoenix Technologies Ltd.

Imation, the Imation Logo, the circle-pyramid logo, SuperDisk and SuperDisk logo are trademarks of Imation Corp.

Acrobat is a registered trademark of Adobe Systems Incorporated.

Panasonic is a registered trademark of Matsushita Electric Industrial Co., Ltd.

## For U.S.A.

### Federal Communications Commission Radio Frequency Interference Statement

Note: This equipment has been tested and found to comply with the limits for a Class B digital device, pursuant to Part 15 of the FCC Rules. These limits are designed to provide reasonable protection against harmful interference in a residential installation. This equipment generates, uses and can radiate radio frequency energy and, if not installed and used in accordance with the instructions may cause harmful interference to radio communications. However, there is no guarantee that interference will not occur in a particular installation. If this equipment does cause harmful interference to radio or television reception, which can be determined by turning the equipment off and on, the user is encouraged to try to correct the interference by one or more of the following measures:

- Reorient or relocate the receiving antenna.
- Increase the separation between the equipment and receiver.
- Connect the equipment into an outlet on a circuit different from that to which the receiver is connected.
- Consult the Panasonic Service Center or an experienced radio/TV technician for help.

### Warning

To assure continued compliance, use only shielded interface cables when connecting to a computer or peripheral. Also, any changes or modifications not expressly approved by the party responsible for compliance could void the user's authority to operate this equipment.

This device complies with Part 15 of the FCC Rules. Operation is subject to the following two conditions:

- (1) This device may not cause harmful interference, and
- (2) This device must accept any interference received, including interference that may cause undesired operation.

Responsible Party: Matsushita Electric Corporation of America  
One Panasonic Way  
Secaucus, NJ 07094  
Tel No: 1-800-LAPTOP-5 (1-800-527-8675)

## Lithium Battery

### Lithium Battery!

This computer contains a lithium battery to enable the date, time, and other data to be stored in it.

The battery should only be exchanged by service personnel.

Warning! Risk of explosion from incorrect installation or misapplication!

### Avertissement concernant la pile au lithium (pile de sauvegarde)

Pile au lithium!

Le micro-ordinateur renferme une pile au lithium qui permet de sauvegarder certaines données comme la date et l'heure notamment. Elle ne devra être remplacée que par un technicien qualifié.

Avertissement! Risque d'explosion en cas de non respect de cette mise en garde!

## Precautions

The CF-27 was developed based on thorough research into the real-world portable computing environments. Exhaustive pursuit of usability and reliability under harsh conditions led to innovations such as the magnesium alloy exterior, vibration damped hard disk drive and floppy disk drive, flexible internal connections. The CF-27's outstanding engineering has been tested using the stiff MIL-STD- 810E (for vibration and shock) and IP (for dust and water) based procedures.

As with any portable computer device precautions should be taken to avoid any damage. The following usage and handling procedures are recommended.

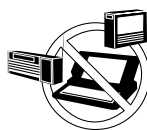

### Avoid Radio Frequency Interference

Do not place the computer near a television or radio receiver.



### Avoid Magnetic Fields

Keep the computer away from magnets.



### Keep Small Objects Away

Do not insert paper clips or other small objects into the computer.



### Do Not Disassemble the Computer

Do not attempt to disassemble your computer.



### Avoid Excessive Force on the Display

Do not apply excessive downward force on the display when it is completely opened, especially when plugs and/or cables are connected to the rear of the computer.

### ● Peripherals

Incorrectly using peripheral devices may lead to a decrease in performance, an increase in temperature and/or damage your computer. For more information on peripheral devices, please refer to the Reference Manual.

## Precautions (Battery Pack)

- Care should be exercised with regard to the following in order to avoid the possibility of liquid leakage, overheating, or bursting.



### Avoid Heat

Do not throw the battery pack into a fire or expose it to excessive heat.



### Keep Articles Away

Do not place the battery pack together with articles such as necklaces or hairpins when carrying or storing.



### Do Not Disassemble

Do not insert sharp objects into the battery pack, expose it to bumps or shocks, deform, disassemble, or modify it.



### Do Not Short

Do not short the positive (+) and negative (-) contacts.



### Avoid Extreme Heat, Cold and Direct Sunlight

Do not charge, use or leave the battery pack for extended periods where it will be exposed to direct sunlight, in a hot place (in an automobile on a sunny day, for example), or in a cold place.



### Do Not Use With Any Other Computer

The battery pack is rechargeable and was intended for the specified computer or charger. Do not use it with a computer other than the one for which it was designed.



### Do Not Put into a Microwave

Do not put the battery pack into a microwave oven or a pressurized chamber.



### Discontinue Use

Should the battery emit an abnormal odor, become hot to the touch, become discolored, change shape, or become in any way different from normal, remove it from the computer or charger and discontinue use.

- Do not touch the terminals on the battery pack. The battery pack may no longer function properly if the contacts are dirty or damaged.
- Do not expose the battery pack to water, or allow it to become wet.
- If the battery pack will not be used for a long period of time (a month or more), charge or discharge (use) the battery pack until the remaining battery level becomes 30% to 50% and store it in a cool, dry place.
- This computer prevents overcharging of the battery by recharging only when the remaining power is less than approx. 95% of capacity after the battery is fully charged.
- The battery pack is not charged when the computer is first purchased. Be sure to charge it before using it for the first time. When the AC adapter is connected to the computer, charging begins automatically.
- Should the battery leak and the fluid get into your eyes, do not rub your eyes. Immediately flush your eyes with clear water and see a doctor for medical treatment as soon as possible.

### NOTE

- The battery pack may become warm during recharging or normal use. This is completely normal.
- Recharging will not commence outside of the allowable temperature range (0 °C to 35 °C (32°F to 95 °F)). Once the allowable range requirement is satisfied, charging begins automatically. Note that the recharging time varies based on the usage conditions.
- If the temperature is low, the operating time is shortened. Only use the computer within the allowable temperature range.
- Although the battery has remaining capacity, the battery indicator may light up red or emit a beep. This indicates a significant rise in the temperature of the battery pack. This is typically caused by the fact that the battery pack has been delivering a high level of power because the computer has been used with the display at the brightest setting and with the power-saving function off. To protect the battery pack from increases in temperature, the brightness of the display automatically decreases, allowing the temperature of the battery to drop. In this condition, if the computer is left as is, it will automatically go off after about three minutes have elapsed. Within that period, therefore, be sure to connect the AC adapter or shut the computer OFF after saving any open data (if necessary).

# Read Me First

## Saving Data on the Hard Disk

- **Do not expose your computer to shock.**  
Please use care when handling your computer, shock may damage your hard disk or make your software applications and data unusable.
- **Do not power off your computer while software applications are running or HDD indicator (HDD) is on.**  
Properly shut Windows\* down to avoid problems ([Start] - [Shut Down] ).
- **Save all valuable data to floppy disks.**  
Backing up data to floppy disks will limit damage should trouble occur to your computer or should you inadvertently change or erase data.
- **Use the security function for all important data.** (  Reference Manual "Security Measures" )

\* This computer uses Microsoft® Windows® 95 Operating System.

## Saving Data on Floppy Disks

- **Do not power off your computer or press the floppy disk drive eject button while the MP indicator (MP) is on.**  
Doing so may damage the data on the floppy disk and render the disk useless.
- **Use care when handling floppy disks.**  
To protect the data on your floppy disks or to prevent a floppy disk from becoming stuck in your computer, avoid the following:
  - Sliding the shutter on the floppy disk manually.
  - Exposing the disk to a magnetic field.
  - Storing the disk in locations prone to high temperatures, low pitched noise, dampness, or dust.
  - Applying more than one label on the disk.
- **Confirm the contents of a floppy disk before formatting it.**  
Confirm that no important data is on the disk, because all data on the disk will be erased.
- **Use the write-protect tab.**  
This is a must for preserving important data. This prevents your data from being erased or overwritten.

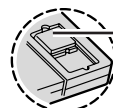

Write Enable

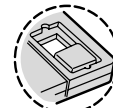

Write Disable

## Computer Viruses

- **Users are advised to purchase the latest versions of virus protection software and use them regularly.**  
We recommend you run the software:
  - When booting your computer.
  - After receiving data.We recommend that you check data received on floppy disks or from external sources, such as data downloaded from the Internet, e-mail, etc. (For compressed files, please uncompress them before running a check).

# First-time Operation







Please read the steps below to help you learn what parts are included, and to gain an understanding of some basic computer-related operations.

## 1 Confirm the inclusion of all parts

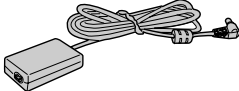
Make sure the parts shown in the figure have been supplied. If any of these items are missing or is not working properly, please contact Panasonic Technical Support.

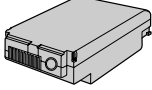
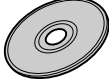
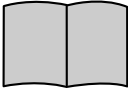
### CAUTION

Have 2HD floppy disks prepared to create disks that will allow you to reinstall the operating system should a problem occur. Be sure that these disks are not write-protected. (It is not necessary for these disks to be preformatted.)

<b>AC Adapter ..... 1</b>  CF-AA1639	<b>AC Cord ..... 1</b> 
<b>Battery Pack ..... 1</b>  CF-VZSU04	<b>FIRSTAID CD ..... 1</b> 
<b>Operating Instructions ..... 1</b> 	<b>Windows 95 System Pack .... 1</b>  Windows® 95 Book  Registration Card  CD-ROM

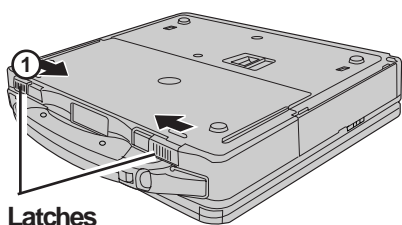

Latches

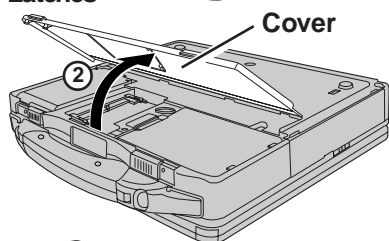

Cover

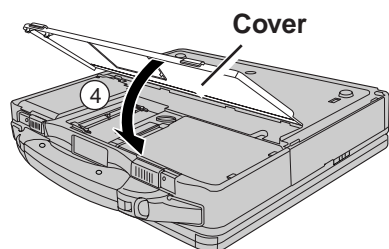
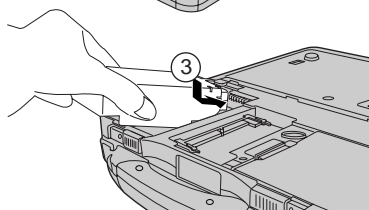

Cover

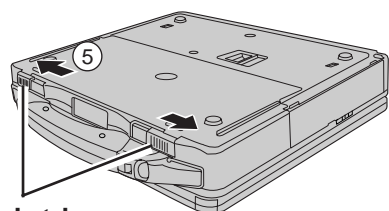

Latches

## 2 Connect the battery pack

- ① Turn your computer over and slide the latches.
- ② Lift open the cover holding both sides and remove it.
- ③ Put a battery pack into the computer and slide the battery pack inward until it is firmly in place.
- ④ Attach the cover holding both sides.
- ⑤ Slide the latches.

### CAUTION

- Be sure the battery pack is properly connected to the connector.
- Do not touch the battery connector on the computer. The computer may not operate properly.

#### When attaching the cover;

Be careful not to get your fingers caught in the cover.

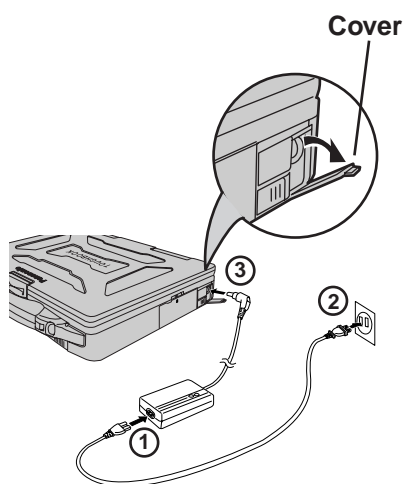

## 3 Connect your computer to a power outlet

### CAUTION

Be sure the AC adapter is connected until completing Step 8 on page 9.

#### Handling the AC adapter

- Do not twist or pull the AC power cord forcefully. Doing so may damage the connections.
- Use only the specified AC adapter with your computer. Using an AC adapter other than the one supplied might damage the battery and/or the computer.
- When the DC plug is not connected to the computer, disconnect the AC cord from your AC wall outlet.
- Problems such as sudden voltage drops/surges may arise during periods of thunder and lightning. Since this could adversely affect your computer, an uninterruptible power source (UPS) is highly recommended unless the battery pack is installed.

#### When closing the cover

First insert the top of the cover, then close the cover.



# First-time Operation

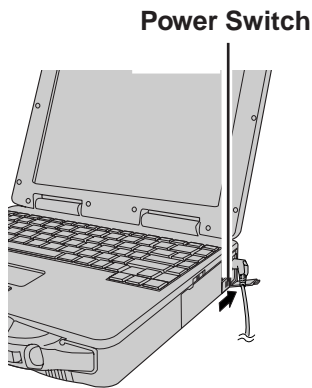

## 4 Read the LIMITED USE LICENSE AGREEMENT (☞ page 23)

Before removing the seal covering the power switch, please read the LIMITED USE LICENSE AGREEMENT. Removal of this seal indicates agreement to the terms specified. After you have agreed to the terms, you may turn your computer on.

## 5 Turn your computer on

Slide the power switch toward the rear of the computer and hold it for approximately one second until the power indicator (Ⓛ) turns on before releasing it.

### CAUTION

- After confirming that the power indicator has turned on, do not touch the power switch until Windows setup has started.
- Once the computer is powered off, you must wait at least ten seconds before powering it on again.

### NOTE

The power saving function is factory set, so if there is no input from a key, the touch pad, or the external mouse for two minutes, the power to the LCD is cut (ECO mode ☞ Reference Manual "Computing on the Road" )\*.

The LCD will resume operation when the touch pad is used or a key is pressed. The computer may enter the ECO mode while Windows is setting up or even when an application software is being installed. In this case, because it is conceivable that a selection dialog box will be shown, for resuming from the ECO mode, do not press **Enter** which may trigger a selection, but instead, press a key unrelated to the direct triggering of a selection, like **Ctrl** .

\* Except the devices connected to the USB port such as a USB mouse.

## 6 Setup Windows 95

- ① Select settings for your region, then press [Next].

### NOTE

Moving the cursor (Ⓛ) or clicking buttons can be performed with the touch pad. (☞ page 12)

- ② Select your keyboard layout, then press [Next].  
(for U.S.A.: United States 101)
- ③ Enter your name and your company's name, then press [Next].  
(It is possible to omit the company name item.)  
The License Agreement will be displayed.
- ④ After reading the agreement, select [I accept the agreement] or [I don't accept the agreement], then press [Next].

### NOTE

If [I accept the agreement] is selected, the [Certificate of Authenticity] will appear. If [I don't accept the agreement] is selected, the Windows setup will be aborted.

- ⑤ Input the Product Number written on the "Certificate of Authenticity" located in the Windows® 95 book that comes with this computer then press [Next].
- ⑥ Press [Finish].



- ⑦ Input the correct date, time and time zone and press [Close].  
You can also complete these settings at a later time.
- ⑧ If you wish to complete the printer settings, press [Next]. If not, press [Cancel].

**NOTE**

Simply follow the on-screen instructions. You can also complete these settings at a later time.

- ⑨ Press [Next] to install Internet Explorer. Simply follow the on-screen instructions.

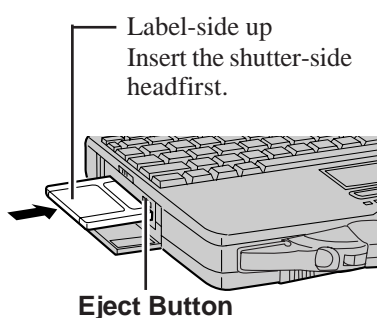

## 7 Create floppy disks

Prepare 2HD floppy disks and make sure they are not in the write-protected state, then select [Start] - [Programs] - [Panasonic] - [Create FIRSTAID FD] and follow the on-screen instructions. Place a label identifying the contents on each disk.

- **Name of created backup disk**

FIRSTAID FD

(When the display for creating the BACKUP DISK is shown, create the disk by following the on-screen instructions.)

**CAUTION**

- Please store the floppy disks in a safe place. They will enable you to return your computer to close to the condition at the time of purchase should any problems occur.  
When creating floppy disks, do not run any other application program.
- When creating floppy disks and the message [Insufficient files to copy] is displayed, click [OK] and then contact Panasonic Technical Support.
- While the MP indicator (MP) is on, do not remove the floppy disk, power down your computer or use the suspend or hibernation function (☞ Reference Manual "Suspend/Hibernation Functions").

## 8 Install the Acrobat® Reader 3.0

**NOTE**

Acrobat® Reader is necessary to view the Reference Manual, which explains detailed operational procedures concerning your computer.

- ① In [Start] - [Run], input [c:\util\avapp\reader\setup.exe], then press [OK].
- ② Press [Next] and set up the Acrobat® Reader 3.0.
- ③ After reading the "Software License Agreement", select [Yes] if you agree to the terms.
- ④ Press [Next].
- ⑤ Press [Finish].  
Read the [Readme] file as necessary. To close the file, click ☒ in the top right corner of the window.
- ⑥ Press [OK].

**This concludes the first-time use operation guidelines.**

# Starting Up/Shutting Down

## Starting Up

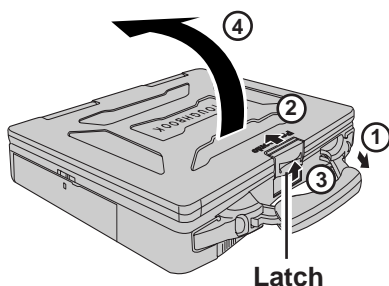

### 1 Open the display

- ① Pull the carry handle forward.
- ② Slide the latch toward the rear of the computer and hold it with one finger.
- ③ Lift up the latch with another finger.
- ④ Lift open the display.

### 2 Turn your computer on

Slide the power switch toward the rear of the computer and hold it for approximately one second until the power indicator turns on before releasing it.

Power Switch

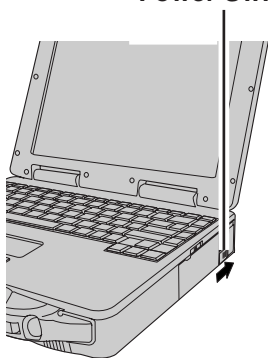

#### CAUTION

- The computer will not power on when the display is closed (except when connecting an external display).
- After confirming that the power indicator has turned on, avoid the following until Windows has completed loading.
  - Touching the power switch.
  - Performing any keyboard or touch pad (or external mouse) operations.
  - Closing the display.

If the display is closed while Windows is starting up, it is possible that color, etc., will not be displayed properly. Run the [MS-DOS Prompt] ([Start] - [Programs] - [MS-DOS Prompt]), and use full screen display mode by pressing **Alt** + **Enter**.

After returning from the full screen mode **Alt** + **Enter** again, the display will be shown correctly.

- Once the computer is powered off, you must wait at least ten seconds before powering it on again.
- When the CPU temperature rises, the computer may not power on to prevent the CPU from overheating. Should this happen, allow the computer to cool down then switch the power on again.

If the computer still does not power on, please contact Panasonic Technical Support.

### ● If security indicator is displayed,

you must first enter your password. (  Reference Manual "Security Measures" )

Upon entering your password and pressing **Enter**.



If the correct password is input,



Over three incorrect attempts,



\* If you are starting from the suspend mode (  Reference Manual "Suspend/Hibernation Functions" ), if after three attempts the correct password is not input, or if no password is entered for about a minute, the computer returns to the suspend mode.

### ● When an application or file that was previously displayed appears on your screen,

the suspend or hibernation function has been set. (  Reference Manual "Suspend/Hibernation Functions" )

### 3 Select your application

You are able to start working on your computer.

#### NOTE

- The power saving function is factory set, so if there is no input from a key, the touch pad, or the external mouse for two minutes, the power to the LCD is cut (ECO mode).  
The LCD will resume operation when the touch pad is used or a key is pressed.
- [System Devices] in [Start] - [Settings] - [Control Panel] - [System] - [Device Manager] may contain a device or devices bearing an exclamation mark or question mark. This does not indicate a malfunction. Such a mark (exclamation or question mark) will not be displayed if the operating environment of the device showing the mark is corrected, by for instance installing the driver of the device.

## Using the Touch Pad

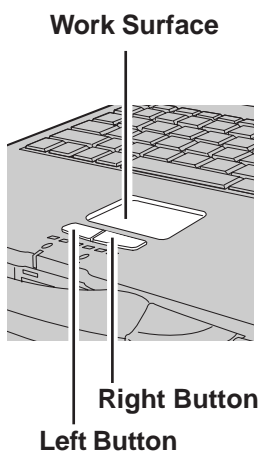

Use the touch pad to move the cursor on the display and perform normal computer operations. For instructions on how to handle the touch pad, refer to page 14.

The touch pad has the following two modes of operation.

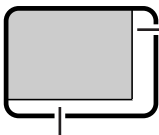
Microsoft® IntelliMouse™ Wheel Mode (Setting at the time of purchase)	Original Mode
<p>Wheel mode operations (almost identical to the case of using the Microsoft® IntelliMouse™ for scroll, zoom, etc., operations) are possible for Microsoft® wheel function-compatible applications.</p> <p>Microsoft® IntelliMouse™ is a mouse-type device that, in addition to the two conventional buttons, incorporates a wheel able to rotate forwards/backwards.</p>	<p>Only scroll operation is possible for applications not compatible with the Microsoft® wheel function.</p> <p>Even for applications compatible with the Microsoft® wheel function, there are cases where only vertical scrolling or only horizontal scrolling is possible in this mode.</p>
<p><b>Scrolling Area</b></p>  <p>For the Pan and Auto Scroll functions, the entire work surface of the touch pad can be used for scrolling.</p>	<p><b>Scrolling Area</b></p>  <p><b>Scrolling up/down</b> Possible when a check mark ✓ is added for [Vertical].</p> <p><b>Scrolling side-to-side</b> Possible when a check mark ✓ is added for [Horizontal].</p>

 : Typical mouse operations use this area.

When no check mark is added for [IntelliMouse Wheel mode], [Horizontal] and [Vertical] of [Scroll Configuration], the entire surface can be used for typical mouse operations.

#### NOTE

When you are not sure whether an application is compatible with the Microsoft® wheel function or not, try using both modes. Furthermore, depending on the application, there are cases where scrolling may not be possible with either mode.

### ● Changing the mode of the touch pad

- 1 Select  from the taskbar and then select [Motion] or select [Motion] in [Start] - [Settings] - [Control Panel] - [Mouse].
- 2 ● To set the Microsoft® IntelliMouse™ Wheel mode  
Add the check mark ✓ for [IntelliMouse Wheel mode] of [Scroll Configuration].  
● To set the original mode  
Delete the check mark for [IntelliMouse Wheel mode] of [Scroll Configuration] and add the check mark ✓ for [Horizontal] and/or [Vertical].
- 3 Press [OK].



# Starting Up/Shutting Down

## Basic Operation

**Wheel** Indicates an operation applicable to the Microsoft® IntelliMouse™ Wheel mode.

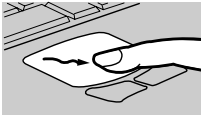
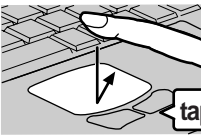
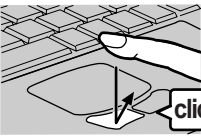
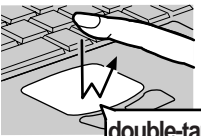
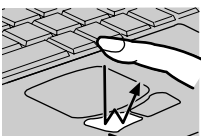
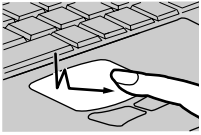
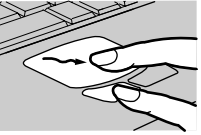
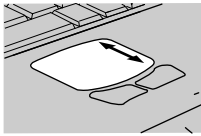
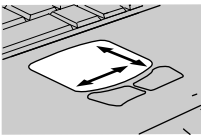
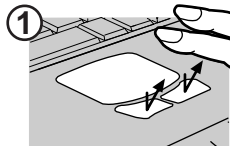
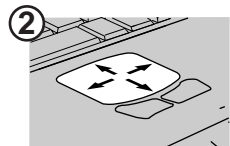
**Original** Indicates an operation applicable to the original mode.

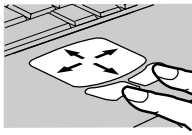
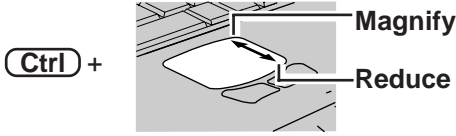
Function		Touch Pad Operation	
<b>Moving the Cursor</b>	<b>Wheel</b> <b>Original</b>		Move the tip of your finger lightly over the surface.
<b>Tapping/Clicking</b>	<b>Wheel</b> <b>Original</b>	 <b>tapping</b>	or  <b>clicking</b>
<b>Double-Tapping/ Double-Clicking</b>	<b>Wheel</b> <b>Original</b>	 <b>double-tapping</b>	or  <b>double-clicking</b>
<b>Dragging</b>	<b>Wheel</b> <b>Original</b>		 <p>Two quick taps, but on the second tap leaving your finger down (applying pressure) and moving it on the work surface.</p> <p>While holding down the button, moving your finger on the work surface.</p> <p>● <b>When a check mark ✓ is added for [use Drag Lock] *</b></p> <p>After the drag operation (above : left side), it is necessary to determine the destination (i.e., location of drop) by one tap. Under the condition no destination is selected, do not use the suspend or hibernation function. Nothing is shown on the display, even after resuming from the suspend or hibernation mode.</p> <p>In this case, the display will return after a tap or click is made.</p> <p>* In [Start] - [Settings] - [Control Panel] - [Mouse] - [Tap and Buttons]</p>
<b>Scroll*</b>	<b>Wheel</b> <b>Original</b>	 <b>Wheel</b>	 <b>Original</b>
<b>Auto Scroll*</b>	<b>Wheel</b>	 <b>1</b>	 <b>2</b>
Automatically scroll a document (move the mouse after clicking the wheel)		<p>Operate after pressing the two buttons simultaneously.</p> <p>● <b>When releasing the auto scroll function:</b> One tap on the work surface.</p>	

Function	Touch Pad Operation
<b>Pan*</b> (Wheel) Scroll in various directions of a document (move the mouse slightly while holding down the wheel)	 Operate while holding down the two buttons.
<b>Zoom*</b> (Wheel) Magnify/reduce the display of a document. (rotate the wheel while holding down <b>Ctrl</b> )	 <b>Ctrl</b> +
<b>Data Zoom*</b> (Wheel) Display or hide a document, or perform operations to return to or proceed with Internet Explorer. (rotate the wheel while holding down <b>Shift</b> )	 <b>Shift</b> +

Within the parentheses ( ) are operations to follow when using an external Microsoft® IntelliMouse™.

\* Indicates that the movements will differ depending on the application.

### CAUTION

- When an external mouse or trackball with additional functions (e.g., wheel function) is connected, a part or all of the additional functions may not function. To use these additional functions, install the driver or application software of the external device by following the procedure below. However, once the driver or application software is installed, it is possible that a part of the functions of the touch pad (e.g., auto scroll) will no longer operate even when the touch pad is enabled again (see the procedure for “When you want to re-enable the touch pad.”).

- 1 Select [Mouse] in [Start] - [Settings] - [Control Panel].
- 2 Select [General] in [Mouse Properties], and then select [Change].
- 3 Select [Show all devices].
- 4 Select [(Standard mouse types)] for [Manufacturers:], select [Standard PS/2 Port Mouse] for [Models:], then select [OK].
- 5 Select [Close]. At the message asking whether to restart the computer, select [No].
- 6 Power off your computer (☞ page 14) and connect the external mouse or trackball device to the computer.
- 7 Turn the power on and run the Setup Utility (☞ Reference Manual "Setup Utility"). In [System Setup], set [Touch Pad] to [Disable] and close the Setup Utility.
- 8 Following the operating instructions for the connected external mouse, install the necessary driver.

After the installation, be sure to [Disable] setting for [Touch Pad] of the Setup Utility.

#### When you want to re-enable the touch pad;

- 1 Perform steps 1 to 5 of the procedure shown above.
- 2 Power off your computer (☞ page 14) and remove the external mouse or trackball device.
- 3 Turn the power on and run the Setup Utility (☞ Reference Manual "Setup Utility"). In [System Setup], set [Touch Pad] to [Enable] and close the Setup Utility.
- 4 Perform steps 1 to 3 of the procedure shown above, select [Matsushita] for [Manufacturers:] and [Touch Pad] for [Models:], then select [OK].
- 5 Select [Close]. At the message asking whether to restart the computer, select [Yes].

# Starting Up/Shutting Down

## NOTE

The double-tapping speed of the touch pad cannot be changed, even if the setting for [Double-click Speed] in [Start] - [Settings] - [Control Panel] - [Mouse] - [Tap and Buttons] is changed.

## Handling the Touch Pad

- When using a key combination such as **(Fn) + (F5)**, do not touch the touch pad. If a key combination is used while the pad is being touched, the function of the key combination will not work. In addition, it is possible that control of the cursor will be lost and the cursor will not show proper movements. In such cases, the computer has to be restarted by using the keyboard (e.g., ) .
- Do not place any object on the work surface or press down forcefully with sharp-pointed objects (i.e. nails), hard objects or objects leave marks (i.e. pencils and ball point pen).
- Do not allow things that could dirty the touch pad, such as oil. The cursor may not work properly in such cases.
- When the touch pad becomes dirty:  
Wipe to remove dirty areas by using a dry soft cloth such as gauze or a soft cloth first applied with detergent diluted with water and then thoroughly wrung.  
Do not use benzene or thinner, or disinfectant-type alcohol.

## Shutting Down (power off your computer)

This procedure is shutting down without using the suspend or hibernation function.

 Reference Manual "Suspend/Hibernation Functions")

### 1 Display the shut down screen

After saving important data and closing each application, select [Shut Down] from the [Start] menu.

## NOTE

**From the keyboard,**

You may choose to press down on  , then select the menu with  or .

### 2 Confirm shut down

Select [Shut down].

Your computer will power off automatically.

(In the OFF state, if you are not recharging your battery pack or if the pack is fully charged, your computer consumes approximately 1.5 W.)

#### ● Restarting your computer (without shutting down)

Select [OK] after selecting [Restart].

## NOTE

**To quickly resume computer operation after shutting down,**

The suspend or hibernation function is available. ( Reference Manual "Suspend/Hibernation Functions")

## About the Reference Manual

The Reference Manual can be accessed on your computer. When a printer is connected, it is also possible to print.

This manual explains functions for you to make greater use of the computer, such as how to add peripheral devices, how the Setup Utility works and other useful information.

### CAUTION

When you read the Reference Manual, it is necessary to install the Acrobat® Reader 3.0. (☞ page 9)

## Run the Reference Manual

**1** Turn your computer on

**2** Select [Reference Manual] in [Start] - [Programs] - [Panasonic]

**Zoom-in** — Go forward or back a page, or to the beginning or end of a document.

**Hand tool** — To move around the current page.

**Cancel or correct an operation**

**Change the display size**

**Perform a "find" operation**

**Exit**

**Table of Content (Items)** — By clicking an item, the corresponding page will be displayed at 100%.

**Display of the manual**

**Movable splitter bar** — This bar can be dragged, for example, to the right to enlarge the display of the Table of Contents.

**Change the display size** — You can choose to magnify/de-magnify the display.

**Page indicator** — A desired page can be displayed by inputting the page number after clicking here.

(The display may be changed without notification.)

Contents	
Key Combinations	2
LED Indicators	3
Panasonic Handwriting (Touch Pad)	4
Suspend/Resume Function	5
Security Measures	9
Computing On the Road	14
Battery Power	17
Using a Multimedia Pocket Device	21
Using PC Cards	23
Adding Memory	25
Port Replicator	26
Using a Printer	27
Using an External Display	28
Using USB Devices	29
Infrared Data Communications	31

### CAUTION

- Illustrations may be difficult to view depending on the magnification. If this is the case, we recommend that the display be magnified.
- When the taskbar is hidden at the bottom portion of Acrobat® Reader, set the maximum display window size.
- If a printer is connected, we recommend printing pages. The illustrations and display samples may not print with a high quality.

# Handling and Maintenance

## Usage Environment

### ● Environment

- Place the computer on a flat stable surface.
- In use: Temperature: 5 °C to 35 °C (41 °F to 95 °F)  
Humidity: 30% to 80% RH (No condensation)
- Not in use: Temperature: -20 °C to 60 °C (-4 °F to 140 °F)  
Humidity: 30% to 90% RH (No condensation)

### ● Places not to use your computer

- Such areas may result in damage to the computer.

#### Areas with electronic equipment

These areas may interfere with your display or cause your computer to produce strange sounds.

#### Areas with extremely high/low temperatures

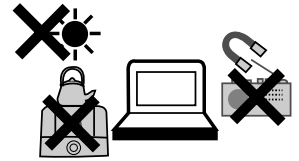

- Do not leave things near the computer that are sensitive to heat. During operation, the computer may become warm.

## Handling

- This computer has been designed so as to minimize shock to the LCD and hard disk drive, the leakage of liquid (e.g., water) from the keyboard, etc., but no warranty is provided against such trouble. Therefore, as a precision instrument, please be extremely careful in the handling.
- Do not drop or hit your computer against solid objects.
- It is a good idea to make backup copies on floppy disks and carry them with you.
- Do not leave a floppy disk in the drive while transporting your computer.
- Do not carry your computer when it is ON.
- Remove all cables before transporting your computer. Having the optional port replicator is very convenient.
- We recommend preparing a fully charged battery (and optional charger, if possible). When transporting spare batteries inside a package, briefcase, etc., it is recommended that the batteries be stored in a plastic bag.
- Do not place the computer upright. When the computer receives extremely strong shock after falling, the hard disk or floppy disk drive, etc., may become inoperable.
- Do not carry the computer while the display is open, or carry it by gripping the display.
- Do not put anything (e.g., a piece of paper) between the display and keyboard.
- Always carry your computer with you. Never check it in with luggage. For use of the computer inside an aircraft, we recommend asking the airlines regarding their policy on this issue.

## Maintenance

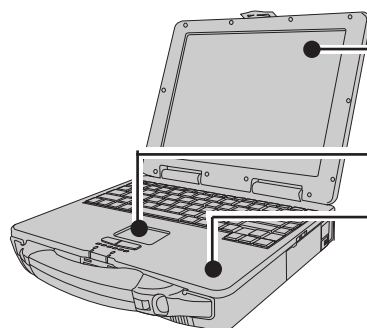

#### Display

Use a soft dry cloth like gauze to lightly wipe the display.

#### Touch Pad

☞ page 14

#### Areas excluding the display

Wipe these areas with a soft cloth, after applying water or detergent diluted with water to the soft cloth and firmly wringing it.

### CAUTION

- Do not use benzene or thinner, or disinfectant-type alcohol.
- Do not directly use water, liquid detergents or spray-type cleaners. If liquid enters the computer, this may cause the computer to malfunction or become defective.



# List of Error Codes





The following is a list of the messages that BIOS can display. Most of them occur during POST. Some of them display information about a hardware device, e.g., the amount of memory installed. Others may indicate a problem with a device, such as the way it has been configured. If your system displays one of the messages marked below with an asterisk (\*), write down the message and contact Panasonic Technical Support. If your system fails after you make changes in the Setup menus, reset the computer, enter Setup and install Setup defaults or correct the error. (  Reference Manual "List of Error Codes" )

- 0200 Failure Fixed Disk
- 0210 Stuck key
- 0211 Keyboard error
- \*0212 Keyboard Controller Failed
- 0213 Keyboard locked - Unlock key switch
- 0220 Monitor type does not match CMOS - Run SETUP
- \*0230 Shadow RAM Failed at offset : *nnnn*
- \*0231 System RAM Failed at offset : *nnnn*
- \*0232 Extended RAM Failed at offset : *nnnn*
- 0250 System battery is dead - Replace and run SETUP
- 0251 System CMOS checksum bad - Default configuration used
- \*0260 System timer error
- \*0270 Real time clock error
- 0280 Previous boot incomplete - Default configuration used
- 0281 Memory Size found by POST differed from CMOS
- 02B0 Diskette drive A error
- 02B1 Diskette drive B error
- 02B2 Incorrect Drive A type - run SETUP
- 02B3 Incorrect Drive B type - run SETUP
- 02D0 System cache error - Cache disabled
- 02F0: CPU ID:
- \*02F4: EISA CMOS not writable
- \*02F5: DMA Test Failed
- \*02F6: Software NMI Failed
- \*02F7: Fail - Safe Timer NMI Failed
- device* address Conflict
- Allocation Error for: *device*
- CD ROM Drive
- Entering SETUP ...
- Failing Bits : *nnnn*
- Fixed Disk *n*
- Invalid System Configuration Data
- I/O device IRQ conflict
- PS/2 Mouse Boot Summary Screen:
- nnnn* kB Extended RAM Passed
- nnnn* Cache SRAM Passed
- nnnn* kB Shadow RAM Passed
- nnnn* kB System RAM Passed
- Operating system not found
- \*Parity Check 1 *nnnn*
- \*Parity Check 2 *nnnn*
- Press <F1> to resume, <F2> to Setup, <F3> for previous
- Press <F2> to enter Setup
- PS/2 Mouse:
- System BIOS shadowed
- UMB upper limit segment address : *nnnn*
- Video BIOS shadowed

# Dealing With Problems

When a problem occurs, please refer to this page. The Reference Manual also contains detailed information. If you still cannot troubleshoot the problem, please contact Panasonic Technical Support.

## ● Starting Up

The power indicator or battery indicator is not lit	<ul style="list-style-type: none"> <li>● Check the cable connection for the AC adapter.</li> <li>● Check to see if a fully charged battery is properly installed.</li> <li>● Remove the battery pack and disconnect the AC adapter, then connect them again.</li> </ul>
 or  is displayed	Please input your password. If you have forgotten it, contact Panasonic Technical Support.
[POST Startup Error(s)] is displayed	 page 17
The pre-memory count, Windows startup, or an operation is extremely slow	Press <b>(F9)</b> in the Setup Utility (  <small>Reference Manual</small> "Setup Utility"). This will restore the Setup Utility's settings to their default values (except the password settings). Then, the Setup Utility must be run once again for you to input the appropriate operating environment settings. (The processing speed depends on the application software used, so this operation may not cause the processing speed to increase.)
The date and time are incorrect	You can set the date and time through [Date/Time] in [Start] - [Settings] - [Control Panel]. If you continue to experience problems, the internal battery maintaining the clock may need to be replaced. Please contact Panasonic Technical Support.
When the previous item is not the cause	<ul style="list-style-type: none"> <li>● Press <b>(F9)</b> in the Setup Utility ( <small>Reference Manual</small> "Setup Utility"). This will restore the Setup Utility's settings to their default values (except the password settings).</li> <li>● Try removing all peripheral devices.</li> <li>● In the MS-DOS mode, run SCANDISK to check the hard disk.</li> <li>● At start-up, press <b>(F8)</b> to operate the computer in the Safe mode.</li> </ul>

## ● Battery Indicator

The red indicator lights. Repeated beeping sound while the computer is in use.	The battery level is low. Save your data and power off your computer. After connecting the AC adapter or replacing the battery pack with a fully charged one, turn your computer on.
The red indicator blinks	<ul style="list-style-type: none"> <li>● The battery pack or recharging function may be defective. Quickly remove the battery pack and disconnect the AC adapter, then connect them again.</li> <li>● If the problem persists, contact Panasonic Technical Support.</li> </ul>
After the AC adapter is connected, the orange indicator blinks five times	Unable to charge because of an improper temperature range. (  page 4)



## ● Key Combinations

No effect	If the touch pad is touched, the function of a key combination involving <b>(Fn)</b> will not work.
-----------	---

## ● Character Input

Unable to input anything but numerals	If <b>NumLk</b> and <b>Key Pad</b> are on, the Numeric Key Pad is ON. To switch it OFF, press <b>(Fn) + (Key Pad)</b> .
Only capital letters are being input	If <b>CapsLock</b> is on, the Caps Lock function is ON. To switch it OFF, press <b>(Caps Lock)</b> .
How to input European characters (ß, à, ç) or symbols is unclear	Select [Start] - [Programs] - [Accessories] - [Character Map]. The Character Map will be displayed. Point to the desired font name and select it.

## ● Display

<p><b>No display after powering on</b></p>	<ul style="list-style-type: none"> <li>● At the time of purchase, the display setting is preset for an external display. If you connect an external display, the screen is displayed on the external display.</li> <li>● When there is no display to an external display,             <ul style="list-style-type: none"> <li>• Check your cable connection to the external display.</li> <li>• Confirm your display is powered on.</li> <li>• Check the settings for your external display.</li> </ul> </li> <li>● Try changing the display by pressing <b>(Fn) + (F3)</b>.</li> <li>● When displaying only through an external display, if the computer is shut down by using the suspend or hibernation function, there will be no display on the LCD unless the external display is connected when operations are resumed. In this case, connect the external display.</li> </ul>
<p><b>The power has not been cut, but after a certain period of time, there is no display</b></p>	<ul style="list-style-type: none"> <li>● Has the computer been set to the power-saving mode? To resume operation of your computer from ECO mode, press any key.</li> <li>● To save power, your computer may have automatically entered the suspend or hibernation mode. (  Reference Manual "Computing On the Road")</li> </ul>
<p><b>The resolution of the display cannot be changed</b></p>	<p>Set [None] for [Wallpaper] in [Start] - [Settings] - [Control Panel] - [Display] - [Background], and then press [OK]. Then, once again try changing the resolution. After the change, be sure to restart the computer.</p>
<p><b>An afterimage appears</b></p>	<p>If an image is displayed for a prolonged period of time, an afterimage may appear. This is not a malfunction. The afterimage will disappear when a different screen is displayed.</p>
<p><b>The motion of the mouse cursor is not smooth</b></p>	<p>Select [Start] - [Settings] - [Control Panel] - [Mouse] - [Motion] and add the check mark ✓ for [Show trails].</p>
<p><b>The cursor does not move in scrolling area of the touch pad</b></p>	<p>When the Microsoft® IntelliMouse™ Wheel mode or the original mode is set for the touch pad, only scroll operations are possible for the right part or bottom part of the touch pad. In this case, cursor operations are possible by using the work surface excluding the right part or bottom part. When no mode is set, the entire surface of the touch pad can be used for cursor operations. (  page 11)</p>
<p><b>The cursor cannot be controlled</b></p>	<p>Was the touch pad touched while a key combination (such as <b>(Fn) + (F5)</b>) was being used? In this case, restart the computer by using the keyboard (e.g., .</p>

## ● Disk Operations

<p><b>Cannot read/write to a floppy disk</b></p>	<ul style="list-style-type: none"> <li>● Has the floppy disk been correctly inserted?</li> <li>● Has the floppy disk been correctly formatted?</li> <li>● Has the Setup Utility been used to set [Floppy Operation] to [Enable]? (  Reference Manual "Setup Utility")</li> <li>● Your floppy disk content may be corrupted.</li> </ul>
<p><b>Unable to write to a floppy disk</b></p>	<p>Is the floppy disk write-protected?</p>
<p><b>How to format a floppy disk is unclear</b></p>	<p>Select [Format] in [My Computer] - [3 1/2 Floppy (A:)] - [File]. After confirming the disk volume and format type, start formatting.</p>
<p><b>Unable to read/write to the hard disk</b></p>	<ul style="list-style-type: none"> <li>● Your drive or file may not have been properly set.</li> <li>● Check to see if the hard disk is full. If it is full, delete unnecessary files.</li> <li>● Your hard disk content may be corrupted. Contact Panasonic Technical Support.</li> </ul>
<p><b>When the previous item is not the cause</b></p>	<p>Try testing another drive or media.</p>

# Reinstalling Software

## Before Reinstallation

### ● Preparing

- You will need the FIRSTAIID CD, CD-ROM included in the Windows 95 System Pack and the FIRSTAIID FD you made earlier.

#### NOTE

If you have not created the FIRSTAIID FD, you can create by selecting [Create FIRSTAIID FD] in [Start] - [Programs] - [Panasonic]. If you can not create this disk, please contact Panasonic Technical Support.

- The CD-ROM pack (CF-VCD271) and FDD cable (CF-VCF271) are required for the following reinstallation procedure. Mount the CD-ROM pack in the multimedia pocket and connect the FDD cable to the floppy disk drive. (Refer to the operating instructions of the CD-ROM pack and FDD cable for details.)

#### NOTE

**When using a CD-ROM drive other than CF-VCD271 (e.g., by connecting it through a PC Card);**

- For the CD-ROM drive to be properly recognized

It is necessary to copy the CD-ROM driver to the FIRSTAIID FD with the method below. However, after hard disk is formatted, the operation below is not possible.

Before performing the operation below, we recommend creating a duplicate of the FIRSTAIID FD with the DISKCOPY command.

1 Start Windows and insert the FIRSTAIID FD.

2 Select [Start] - [Programs] - [Accessories] - [Notepad] and open [a:\config.sys].

3 Rewrite the following line and save.

```
REM *****  
Device=A:\UP\WINDOWS\COMMAND\ATAPICD.SYS /D:MSCD000
```

— Rewrite this driver for the driver of your CD-ROM drive. Please refer to the operation manual that accompanies the CD-ROM drive.

If you connect a CD-ROM drive through a PC card, the driver for the PC Card will be necessary. Refer to the operation manual that accompanies the CD-ROM drive.

4 Copy the CD-ROM driver file (i.e., the driver file rewritten in step 3) of the CD-ROM drive below [a:\up\windows\command] of the FIRSTAIID FD.

5 Set the floppy to the write-protect state.

- When using a CD-ROM drive not supported by Windows 95

After reinstalling Windows 95 (after step 11 on page 21), there is a need to install the proper driver software. Refer to the operation manual that accompanies the CD-ROM drive.

- There are cases the reinstallation procedure will slightly differ.

### ● Important

- Save all important data. If reinstallation is carried out, all data existing prior to the installation will be lost. The reinstallation will return the computer to close to the conditions at time of purchase.
- Before the reinstallation procedure, remove all peripherals (except for the CD-ROM drive and FDD cable).
- Be sure the AC adapter is connected until the reinstallation procedure is completed.

## Reinstalling

### ● Windows 95 (HDD format)

#### CAUTION

If data on your hard disk is compressed, the data should be uncompressed.

- 1 Insert the FIRSTAIID FD, and turn the computer on; this screen should appear.

Microsoft Windows 95 Startup Menu

1. Boot
2. Initialize the HDD for the Hibernation function
3. Restore the HDD to factory default

Enter a choice: 1

- 2 ● To use the hibernation function, follow this procedure and be sure to create the hibernation partition.

- If you decide not to create the hibernation partition, go on to step ④ after restarting the computer by pressing **Alt** + **Ctrl** + **Del**.

① Select [2.Initialize the HDD for the Hibernation function].

② At the confirmation message, press **Y**.

③ When the message [Press any key to continue...] is displayed, confirm that the FIRSTAIID FD has been set in the floppy drive, and then press a key. The computer will reboot.

- ④ When the message [Press F2 for Setup] is displayed, press **(F2)** and then run the Setup Utility.
- ⑤ Press **(F9)**.  
At the confirmation message, select [Yes] and press **(Enter)**.
- ⑥ Select [Power] menu and set [Power Management Mode] to [Off] and [Power Switch] to [Off].
- ⑦ Press **(F10)**.  
At the confirmation message, select [Yes] and press **(Enter)**. The computer will reboot, and will then return to the display shown in step 1.

### ● Windows 95 (reinstalling)

- 3 Select [3. Restore the HDD to factory default].
- 4 At the confirmation message, press any key.
- 5 When your computer prompts you to insert the FIRST AID CD, please set the specified CD and press any key.
- 6 When your computer prompts you to insert the "Windows 95 CD", please set the specified CD and press any key.
- 7 When the [To continue, press ENTER...] appears, press **(Enter)**.  
After Microsoft ScanDisk completes, the computer will automatically return to the Windows 95 setup. Simply follow the on-screen instructions.

#### NOTE

- With the exception of the instruction below, please select all default values displayed by the Setup Wizard. Be sure to add the check mark ✓ to [Sound, MIDI, or Video Capture Card] at the [Analyzing Your Computer].
- Have a floppy disk on hand to create a "Windows 95 Startup Disk". Immediately after creating this disk, enter the FIRST AID FD into the floppy disk drive and press [OK]. (Note: A system error will result if the FIRST AID FD is not inserted. If this occurs, insert the FIRST AID FD and press [Retry].)

- 8 At the [Finishing Setup], remove the floppy disk and press [Finish]. Windows will restart after all the settings have automatically been made. If the computer asks you to insert the Windows 95 Disk, press [OK]. Input [c:\cabs], then press [OK].
- 9 At the [Date/Time Properties], press [Close].
- 10 At the [Add Printer Wizard], press [Cancel].
- 11 When the display appears indicating the establishment of the system settings, press [OK]. The computer will reboot.

### ● System setup

- 12 In [Start] - [Run], input [c:\install.bat], then press [OK]. Rebooting will be done automatically. It may take several minutes to reboot the computer.
- 13 In [Start] - [Programs] - [Windows Explorer], delete the "c:\install.bat" and "c:\install.pif" files.

### ● Device manager 1

- 14 In [Start] - [Settings] - [Control Panel] - [System] - [Device Manager], select [PCIC or compatible PCMCIA controller] in [PCMCIA socket]. Remove the check for [Disable in this hardware profile] in [Properties] - [General] and then press [OK].
- 15 Press [Next] at the display for the [Welcome to the PC Card (PCMCIA) Wizard], press [Next] again and then press [Finish].
- 16 The display will ask you to restart Windows, press [No].
- 17 Check [View devices by connection] at [Device Manager] and select [PCI bus] in [Plug and Play BIOS], press [Remove], then press [OK]. The display will ask you to restart Windows, press [Yes]. Rebooting will be done automatically. If the computer asks you to insert the Windows 95 Disk, press [OK]. Input [c:\cabs], then press [OK].
  - Then, when the [Version Conflict] appears, select [Yes].
- 18 Press [Next] at the [Update Device Driver Wizard of PCI Universal Serial Bus] and [Finish].  
If the display asks you to restart Windows, press [Yes].
- 19 Press [Next] at the [Update Device Driver Wizard of Standard PCI Graphics Adapter (VGA)] and [Finish].  
If the display asks you to restart Windows, press [Yes]. (This message may be displayed several times.)

### ● Sound driver

- 20 In [Control Panel] - [System] - [Device Manager], for each item in [Sound, video and game controller], press [Remove] to delete it, then press [OK] to confirm the deletion.
  - If the display asks you to restart Windows, press [No].
- 21 Press [Refresh] and press [Next] at the [Update Device Driver Wizard of Unknown Devices].
- 22 Select [Other Locations], input [c:\util\drivers\sound], then press [OK].
- 23 At the [Update Device Driver Wizard of YAMAHA OPL3-SAX Sound System], press [Finish].

### ● Video driver

- 24 In [Device Manager] - [Display adapters] - [Standard PCI Graphics Adapter (VGA)] - [Driver] - [Update Driver], select [Yes (Recommended)], then press [Next].
- 25 Select [Other Locations], input [c:\util\drivers\video], press [OK], then press [Finish]. The display will ask you to restart Windows, then press [Yes].

### ● Touch pad driver

- 26 In [Start] - [Settings] - [Control Panel] - [Mouse] - [General] - [Change] - [Have Disk], input [c:\util\drivers\mouse] and press [OK]. Select [touch pad], press [OK] and then press [Close]. The display will ask you to restart Windows, then press [Yes].

# Reinstalling Software

## ● Power management

**27** Delete the check mark for [When powered by AC power] and [When powered by batteries] in [Control Panel] - [Power] - [Disk Drives], then press [OK].

## ● Device manager 2

**28** Add the check mark ✓ for [DMA] in [Control Panel] - [System] - [Device Manager] - [CDROM] - [MATSHITA UJDA150\*] - [Settings].

- Depending on the CD-ROM drive, there are cases in which the check mark can not be added for [DMA].

**29** Set [L:] for [Reserved drive letters], then press [OK].

**30** Add the check mark ✓ for [DMA] in [Device Manager] - [Disk drives] - [GENERIC IDE DISK TYPE\*\*] - [Settings], then press [OK].

**31** Set [Mobile or docking system] in [Performance] - [File System] - [Hard Disk] - [Typical role of this machine], then press [OK].

**32** At the [System Properties], press [Close]. The display will ask you to restart Windows, then press [Yes].

## ● Display driver

**33** Select [Super VGA 1024 X 768] for [Models] in [Control Panel] - [Display] - [Settings] - [Advanced Properties] - [Monitor] - [Change], then press [OK].

**34** Confirm that there is a check mark ✓ for [Automatically detect Plug & Play monitors] in [Options] for the [Monitor], and then press [Close].

**35** Set [High Color (16 bit)] for the [Color palette], set [800 by 600 pixels] for the [Desktop area] and then press [OK].

- If [Compatibility Warning] is displayed, select [Apply the settings without restarting?] and press [OK]. After that, select [OK] at the [Display Properties], and select [YES] at the [Do you want to keep this setting?].

If after a short period of time no action is taken for the [Do you want to keep this setting?], the [Windows has restored your original display settings] will appear. Select [OK] and perform the display settings again.

## ● DMI Viewer setup

**36** Insert the FIRSTAIID CD.

**37** In [Start] - [Run], input [L:\en\dmi\setup.exe], then press [OK].

DMI Viewer setup will start automatically. The display will ask you to restart Windows; press [Finish].

## ● Panasonic Hand Writing setup

**38** Insert the FIRSTAIID CD.

**39** In [Start] - [Run], input [L:\en\writing\setup.exe], then press [OK].

Panasonic Hand Writing Setup will start automatically. Simply follow the on-screen instructions.

## ● Infrared

**40** Select [Control Panel] - [Add New Hardware].

**41** Press [Next] at the [Add New Hardware Wizard].

**42** Select [No], then press [Next].

**43** Select [Infrared] in [Hardware types] and press [Next].

**44** Press [Next], and press [Next] again.

**45** Select [Generic Ir Serial Port [COM2]] in [Select the port that infrared device.....].

**46** From here on, follow the instructions given on the display followed by pressing [Next].

If the computer asks you to insert the Windows 95 Disk, press [OK]. Input [c:\cabs], then press [OK].

**47** Press [Finish].

## Installing Internet Explorer 4.0

Reinstalling Windows causes an older version of Internet Explorer to be installed.

To return the computer to the state it was in when you purchased it, follow the steps below to install the newer version of Internet Explorer.

**1** Insert the Windows 95 CD-ROM included in the Windows 95 System Pack.

**2** In [Start] - [Run], input [L:\win95\ie4setup.exe], then press [OK].

**3** At the [Internet Explorer 4.0 Active Setup], press [Next].

**4** Read the [License Agreement] and select [I accept the agreement], then press [Next].

**5** At the display for [Installation Option], by selecting , select [Full Installation] and then press [Next].

Follow the on-screen instructions.

When the message indicating the end of the installation operation appears, select [OK].

- If a display with the message [Setup was unable to close all programs automatically.] appears, when there is a program in operation, save all data and then select [OK].

**6** The display will ask you to restart Windows, then press [Yes].

## Installing Acrobat® Reader 3.0

☞ page 9, Step 8

## Port Replicator (Option)

After reinstalling the software on the hard disk, different settings are necessary when using the port replicator. For more information, please refer to the operating instructions that accompany the port replicator.

# LIMITED USE LICENSE AGREEMENT

THE SOFTWARE PROGRAM(S) ("PROGRAMS") FURNISHED WITH THIS PANASONIC® PRODUCT ("PRODUCT") ARE LICENSED ONLY TO THE END-USER ("YOU"), AND MAY BE USED BY YOU ONLY IN ACCORDANCE WITH THE LICENSE TERMS DESCRIBED BELOW. YOUR USE OF THE PROGRAMS SHALL BE CONCLUSIVELY DEEMED TO CONSTITUTE YOUR ACCEPTANCE OF THE TERMS OF THIS LICENSE.

Matsushita Electric Industrial Co., Ltd. ("MEI") has developed or otherwise obtained the Programs and hereby licenses their use to you. You assume sole responsibility for the selection of the Product (including the associated Programs) to achieve your intended results, and for the installation, use and results obtained therefrom.

## LICENSE

- A. MEI hereby grants you a personal, non-transferable and non-exclusive right and license to use the Programs in accordance with the terms and conditions stated in this Agreement. You acknowledge that you are receiving only a LIMITED LICENSE TO USE the Programs and related documentation and that you shall obtain no title, ownership nor any other rights in or to the Programs and related documentation nor in or to the algorithms, concepts, designs and ideas represented by or incorporated in the Programs and related documentation, all of which title, ownership and rights shall remain with MEI or its suppliers.
- B. You may use the Programs only on the single Product which was accompanied by the Programs.
- C. You and your employees and agents are required to protect the confidentiality of the Programs. You may not distribute or otherwise make the Programs or related documentation available to any third party, by time-sharing or otherwise, without the prior written consent of MEI.
- D. You may not copy or reproduce, or permit to be copied or reproduced, the Programs or related documentation for any purpose, except that you may make one (1) copy of the Programs for backup purposes only in support of your use of the Programs on the single Product which was accompanied by the Programs. You shall not modify, or attempt to modify, the Programs.
- E. You may transfer the Programs and license them to another party only in connection with your transfer of the single Product which was accompanied by the Programs to such other party. At the time of such a transfer, you must also transfer all copies, whether in printed or machine readable form, of every Program, and the related documentation, to the same party or destroy any such copies not so transferred.
- F. You may not remove any copyright, trademark or other notice or product identification from the Programs and you must reproduce and include any such notice or product identification on any copy of any Program.

YOU MAY NOT REVERSE ASSEMBLE, REVERSE COMPILE, OR MECHANICALLY OR ELECTRONICALLY TRACE THE PROGRAMS, OR ANY COPY THEREOF, IN WHOLE OR IN PART.

YOU MAY NOT USE, COPY, MODIFY, ALTER, OR TRANSFER THE PROGRAMS OR ANY COPY THEREOF, IN WHOLE OR IN PART, EXCEPT AS EXPRESSLY PROVIDED IN THE LICENSE.

IF YOU TRANSFER POSSESSION OF ANY COPY OF ANY PROGRAM TO ANOTHER PARTY, EXCEPT AS PERMITTED IN PARAGRAPH E ABOVE, YOUR LICENSE IS AUTOMATICALLY TERMINATED.

## TERM

This license is effective only for so long as you own or lease the Product, unless earlier terminated. You may terminate this license at any time by destroying, at your expense, the Programs and related documentation together with all copies thereof in any form. This license will also terminate effective immediately upon occurrence of the conditions therefor set forth elsewhere in this Agreement, or if you fail to comply with any term or condition contained herein. Upon any such termination, you agree to destroy, at your expense, the Programs and related documentation together with all copies thereof in any form.

YOU ACKNOWLEDGE THAT YOU HAVE READ THIS AGREEMENT, UNDERSTAND IT AND AGREE TO BE BOUND BY ITS TERMS AND CONDITIONS. YOU FURTHER AGREE THAT IT IS THE COMPLETE AND EXCLUSIVE STATEMENT OF THE AGREEMENT BETWEEN US, WHICH SUPERSEDES ANY PROPOSAL OR PRIOR AGREEMENT, ORAL OR WRITTEN, AND ANY OTHER COMMUNICATIONS BETWEEN US, RELATING TO THE SUBJECT MATTER OF THIS AGREEMENT.

# Contrat de licence d'usage limité

Le(s) logiciel(s) (les "Logiciels") fournis avec ce produit Panasonic® (le "Produit") sont exclusivement concédés en licence à l'utilisateur ultime ("vous"), et ils ne peuvent être utilisés que conformément aux clauses contractuelles ci-dessous. En utilisant les logiciels, vous vous engagez de manière définitive à respecter les termes, clauses et conditions des présentes.

Matsushita Electric Industrial Co., Ltd. ("MEI") a mis au point ou obtenu les Logiciels et vous en concède l'utilisation par les présentes. Vous assumez l'entière responsabilité du choix de ce Produit (y compris des Logiciels associés) pour obtenir les résultats escomptés, ainsi que de l'installation, de l'utilisation et des résultats obtenus.

## Licence

- A. MEI vous octroie par les présentes le droit et la licence personnels, non cessibles et non exclusifs d'utiliser les Logiciels conformément aux termes, clauses et conditions de ce Contrat. Vous reconnaissez ne recevoir qu'un droit limité d'utiliser les Logiciels et la documentation les accompagnant et vous vous engagez à n'obtenir aucun droit de titre, propriété ni aucun autre droit vis-à-vis des Logiciels et de la documentation les accompagnant ni vis-à-vis des algorithmes, concepts, dessins, configurations et idées représentés par ou incorporés dans les Logiciels et la documentation les accompagnant, dont les titres, propriété et droits resteront tous à MEI ou à leurs propriétaires.
- B. Vous ne pouvez utiliser les Logiciels que sur le Produit unique qui est accompagné par les Logiciels.
- C. Vous et vos employés ou agents êtes requis de protéger la confidentialité des Logiciels. Vous ne pouvez ni distribuer ni mettre les Logiciels et la documentation les accompagnant à la disposition d'un tiers, par partage de temps ou de quelque autre manière que ce soit, sans l'autorisation écrite préalable de MEI.
- D. Vous ne pouvez ni copier ni reproduire ni permettre la copie ni la reproduction des Logiciels ni de la documentation les accompagnant pour quelque fin que ce soit, à l'exception d'une (1) copie des Logiciels à des fins de sauvegarde uniquement pour soutenir votre utilisation des Logiciels sur le Produit unique qui est accompagné par les Logiciels. Vous ne pouvez ni modifier ni tenter de modifier les Logiciels.
- E. Vous ne pouvez céder les Logiciels et en octroyer la licence à une autre partie qu'en rapport avec votre cession du Produit unique qui est accompagné par les Logiciels à cette autre partie. Au moment de cette cession, vous devez céder également toutes les copies, que ce soit sous forme imprimée ou lisible par la machine, de tous les Logiciels ainsi que de la documentation les accompagnant, à la même partie ou détruire les copies non cédées.
- F. Vous ne pouvez retirer aucune marque de droits d'auteur, marque ou autre ni aucune identification de produit des Logiciels et vous devez reproduire et inclure toutes ces notices ou identifications de produit sur toutes les copies des Logiciels.

Vous ne pouvez assembler en sens inverse, compiler en sens inverse ni retracer les Logiciels ni aucune de leurs copies, de façon électronique ou mécanique, en tout ou en partie.

Vous ne pouvez utiliser, copier, modifier, altérer ni céder les Logiciels ni aucune de leurs copies, en tout ou en partie, à l'exception de ce qui est expressément stipulé dans ce contrat.

Si vous cédez la possession de toute copie ou de tout Logiciel à une autre partie, à l'exception de ce qui est autorisé au paragraphe E ci-dessus, votre licence est automatiquement résiliée.

## Termes, clauses et conditions

Cette licence n'est effective que pour la durée de possession ou de crédit-bail du Produit, à moins d'une résiliation antérieure. Vous pouvez résilier cette licence à tout moment en détruisant, à vos frais, les Logiciels et la documentation les accompagnant avec toutes leurs copies, sous quelque forme que ce soit. Cette licence sera également résiliée, avec application immédiate, si les conditions de résiliation définies ailleurs dans ce contrat se sont réalisées ou si vous ne respectez pas les termes, clauses et conditions qui y sont contenues. Au moment de la résiliation, vous acceptez de détruire, à vos frais, les Logiciels et la documentation les accompagnant avec toutes leurs copies, sous quelque forme que ce soit.

Vous reconnaissez avoir lu ce contrat, en avoir compris toute la substance et avoir accepté de respecter ses termes, clauses et conditions. Vous reconnaissez en outre qu'ils sont la description complète et exclusive du contrat conclu entre nous, contrat qui remplace et annule toute proposition ou contrat précédent, écrit ou oral, et toute autre communication entre nous, relativement à l'objet du présent contrat.



# Names and Functions of Parts

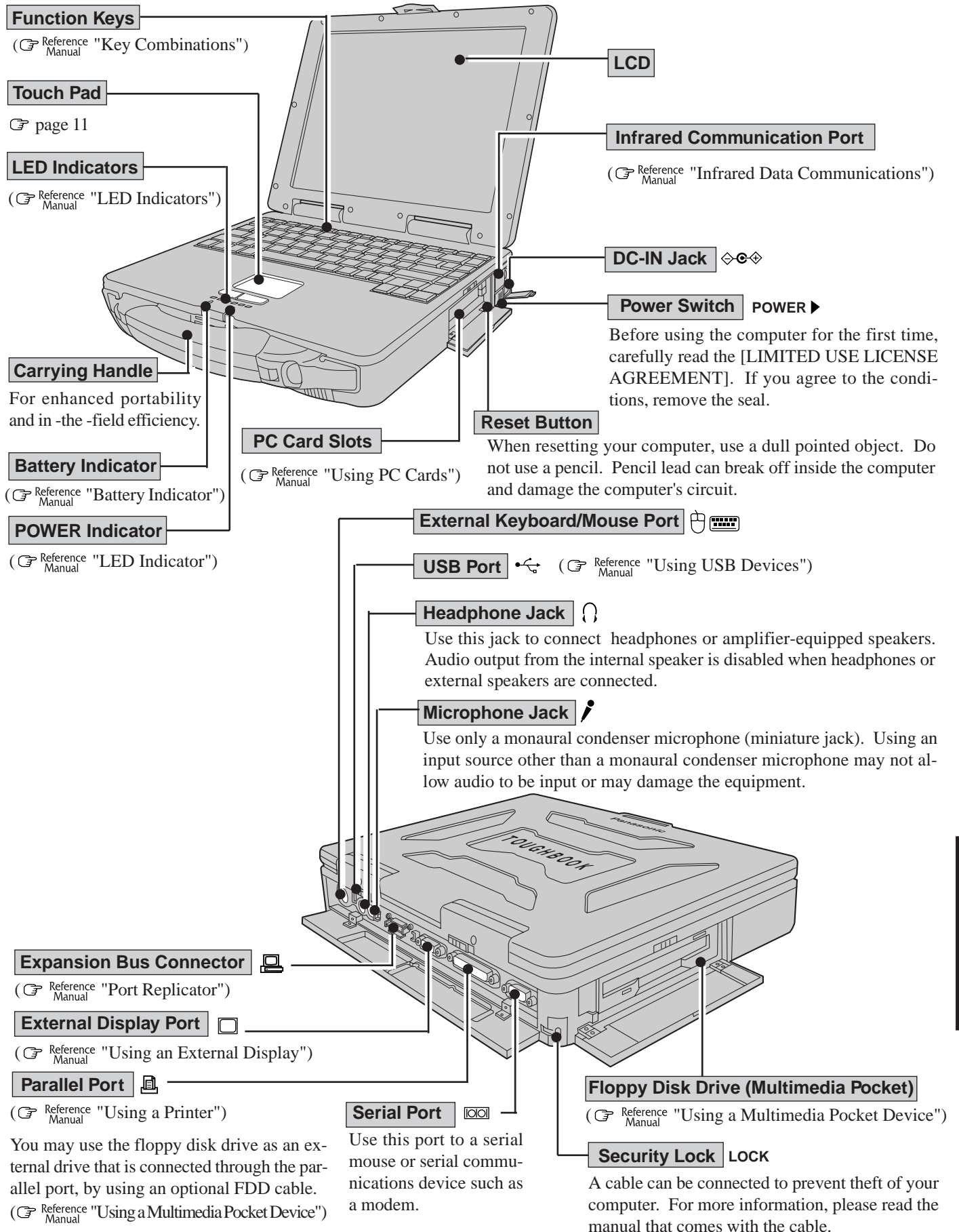

# Names and Functions of Parts

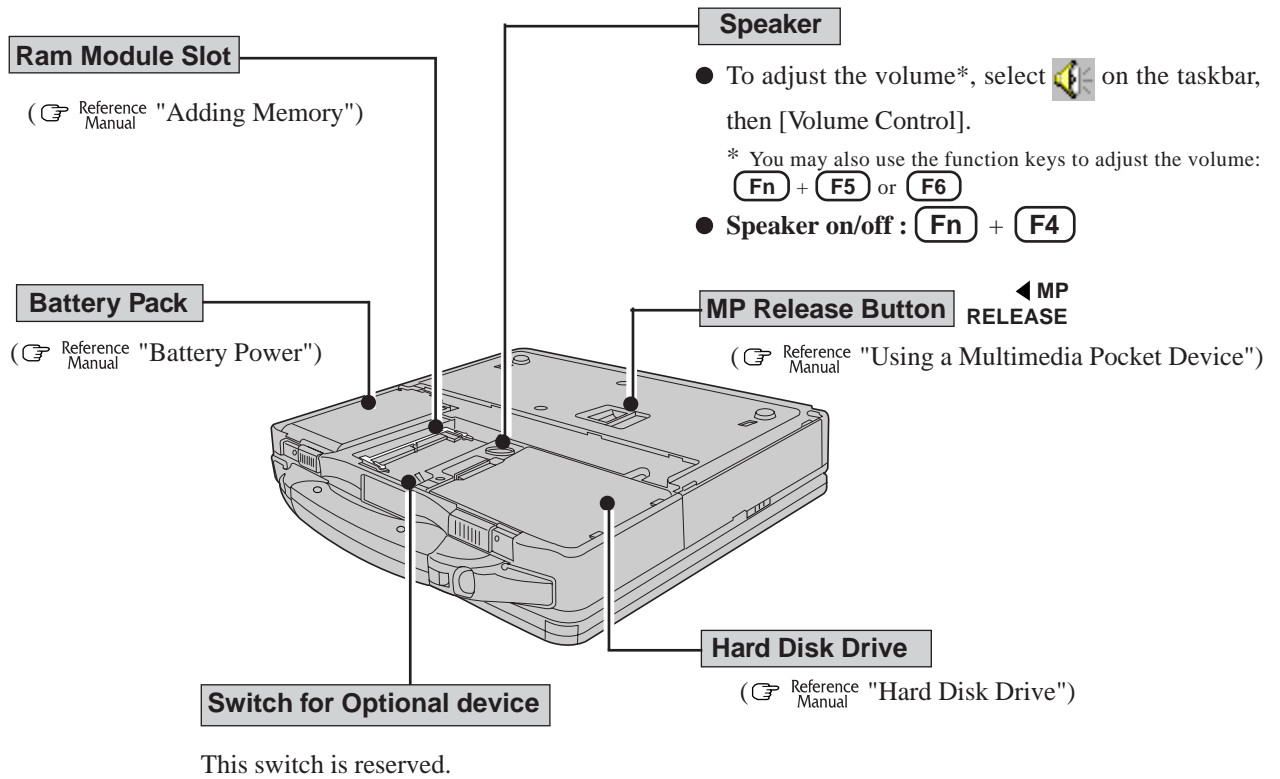

# Specifications

## ● Main Specifications

<b>Model No.</b>		CF-27RJ48AAM	CF-27RG48AAM
<b>CPU</b>		Pentium® Processor with MMX™ technology 266 MHz	
<b>Cache Memory (second cache memory)</b>		32 KB (512 KB)	
<b>Main Memory (Expandable to)</b>		32 MB (96 MB Max. )	
<b>Video Memory</b>		2 MB	
<b>LCD</b>	<b>Type</b>	12.1" (TFT)	10.4" (TFT)
	<b>Displayed Colors*<sup>1</sup></b>	256/65536/262144 colors (640 x 480 dots/800 x 600 dots)	
<b>Hard Disk Drive (including about 200 MB used specifically by the system)</b>		4 GB* <sup>2</sup>	

\*<sup>1</sup> 800 x 600 16-color resolution is not supported. If this resolution is selected, the message "There is an error in the display settings" will appear when you reboot. Start up again, selecting 256 Color, High Color (16 bit), or True Color (24 bit), following the on-screen instructions.

Besides this phenomenon, you might encounter some unexpected behavior. Do not select 16 color mode in any resolution.

\*<sup>2</sup> 1GB = 10<sup>9</sup> bytes

## ● Other Specifications

<b>Keyboard</b>	Windows 95 keyboard (87 keys)			
<b>Floppy Disk Drive</b>	720 KB/1.44 MB (two-mode)			
<b>Slots</b>	PC Card Slots	Two Type I or Type II, or one Type III		
		Allowable current (total for two slots)	3.3 V: 400 mA, 5 V: 400 mA, 12 V: 120 mA	
	RAM Module Slot	144-pin, SO-DIMM, 3.3 V, SDRAM or EDO		
<b>Interface</b>	Parallel Port	Dsub 25-pin female		
	External Display Port	Mini Dsub 15-pin female		
	Serial Port	Dsub 9-pin male		
	Microphone Jack* <sup>1</sup>	Miniature jack, 3.5 DIA Input impedance 600 Ω, Input voltage range 0.01 Vp-p		
	Headphone Jack	Miniature jack, 3.5 DIA Impedance 32 Ω, Output Power 4 mW (Impedance 32 Ω) x 2		
	Infrared Communication Port	IrDA 1.1 compliant, 4 Mbps data transmission speed*		
	External Keyboard/Mouse Port	Mini DIN 6-pin female		
	Expansion Bus Connector	Dedicated 80-pin female		
	USB Port	4-pin		
<b>Pointing Device</b>	Touch Pad			
<b>Speaker</b>	Monaural Speaker (built in)			
<b>Sound</b>	16 bits, 44.1 kHz PCM/FM sound (Sound Blaster PRO Compatible)			
<b>Software</b>	Operating System	Microsoft® Windows® 95 (FAT32 File System)		
	Utility Programs	Setup Utility, DMI Viewer, Panasonic Hand Writing, PhoenixCard Manager™ for Windows® 95		
<b>Battery</b>	Battery Pack	Lithium Ion 10.8 V, 3750 mAh		
	Operating Time	Approx. 3.0 - 5.0 hours* <sup>2</sup>		
	Charging Time	Power On	Approx. 5.5 hours* <sup>3</sup>	
		Power Off	Approx. 2.5 hours* <sup>3</sup>	
	Clock Battery	Coin type lithium battery 3.0 V		
Operating Time		Approx. 7 years		
<b>AC Adapter*<sup>4</sup></b>	Input	100 - 240 V AC, 50 / 60 Hz	Output 15.6 V DC, 3.85A	
<b>Power Consumption</b>	Approx. 42 W* <sup>5</sup> (maximum when recharging in the ON state)			
<b>Physical Dimensions (W x H x D)</b>	301 mm X 58 mm X 241 mm (11.8" X 2.3" X 9.5") (Not including the carrying handle)			
<b>Weight</b>	Approx. 3.5 kg (Approx. 7.7 lbs.) + the carrying handle 0.2 kg (0.4 lbs.)			

\*<sup>1</sup> Use only a monaural condenser microphone (miniature jack).

\*<sup>2</sup> A communications software is necessary.

\*<sup>3</sup> Varies depending on the usage conditions.

\*<sup>4</sup> The AC adapter is compatible with power sources up to 240 V AC. This computer is supplied with a 125 V AC compatible AC cord.

\*<sup>5</sup> Approx. 1.5 W when the battery pack is fully charged (or not being charged) and the computer is OFF.



As an ENERGY STAR® Partner, Panasonic has determined that this product meets the ENERGY STAR® guidelines for energy efficiency.

**Outline of the International ENERGY STAR® Office Equipment Program**

The international ENERGY STAR® Office Equipment Program is an international program that promotes energy saving through the use of computers and other office equipment. The program backs the development and dissemination of products with functions that effectively reduce energy consumption. It is an open system in which business proprietors can participate voluntarily. The targeted products are office equipment such as computers, displays, printers, facsimiles, and copiers. Their standards and logos are uniform among participating nations.